

Approval body for construction products
and types of construction

Bautechnisches Prüfamt

An institution established by the Federal and
Laender Governments



European Technical Assessment

ETA-11/0120
of 19 November 2021

English translation prepared by DIBt - Original version in German language

General Part

Technical Assessment Body issuing the
European Technical Assessment:

Deutsches Institut für Bautechnik

Trade name of the construction product

SB headed studs

Product family
to which the construction product belongs

Steel plate with cast-in anchors

Manufacturer

Bolte GmbH
Flurstraße 25
58285 Gevelsberg
DEUTSCHLAND

Manufacturing plant

Bolte Herstellwerke

This European Technical Assessment
contains

16 pages including 3 annexes which form an integral part
of this assessment

This European Technical Assessment is
issued in accordance with Regulation (EU)
No 305/2011, on the basis of

EAD 330084-00-0601, Edition 01/2016

This version replaces

ETA-11/0120 issued on 6 July 2018

The European Technical Assessment is issued by the Technical Assessment Body in its official language. Translations of this European Technical Assessment in other languages shall fully correspond to the original issued document and shall be identified as such.

Communication of this European Technical Assessment, including transmission by electronic means, shall be in full. However, partial reproduction may only be made with the written consent of the issuing Technical Assessment Body. Any partial reproduction shall be identified as such.

This European Technical Assessment may be withdrawn by the issuing Technical Assessment Body, in particular pursuant to information by the Commission in accordance with Article 25(3) of Regulation (EU) No 305/2011.

Specific Part

1 Technical description of the product

The SB headed studs welded on steel plates consist of steel or stainless steel.

The headed studs have a diameter of the shaft of 10, 13, 16, 19, 22 and 25 mm. At one end a head is formed by upsetting. The other end is prepared for drawn arc stud welding with ceramic ferrule or shielding gas (method 783 according to EN ISO 4063:2002-02).

The steel plates with welded on headed studs are embedded surface-flush in the concrete.

The product description is given in Annex A.

2 Specification of the intended use in accordance with the applicable European Assessment Document

The performances given in Section 3 are only valid if the anchor is used in compliance with the specifications and conditions given in Annex B.

The verifications and assessment methods on which this European Technical Assessment is based lead to the assumption of a working life of the anchor of at least 50 years. The indications given on the working life cannot be interpreted as a guarantee given by the producer, but are to be regarded only as a means for choosing the right products in relation to the expected economically reasonable working life of the works.

3 Performance of the product and references to the methods used for its assessment

3.1 Mechanical resistance and stability (BWR 1)

Essential characteristic	Performance
Characteristic resistance under static and quasi-static loading	See Annex C1 to C2
Displacements	See Annex C1 to C2
Durability	See Annex B1

3.2 Safety in case of fire (BWR 2)

Essential characteristic	Performance
Reaction to fire	Class A1

4 Assessment and verification of constancy of performance (AVCP) system applied, with reference to its legal base

In accordance with EAD No. 330084-00-0601, the applicable European legal act is: [96/582/EC].

The system to be applied is: 1

5 Technical details necessary for the implementation of the AVCP system, as provided for in the applicable EAD

Technical details necessary for the implementation of the AVCP system are laid down in the control plan deposited with Deutsches Institut für Bautechnik.

Issued in Berlin on 19 November 2021 by Deutsches Institut für Bautechnik

Dipl.-Ing. Beatrix Wittstock
Head of Section

beglaubigt:
Müller

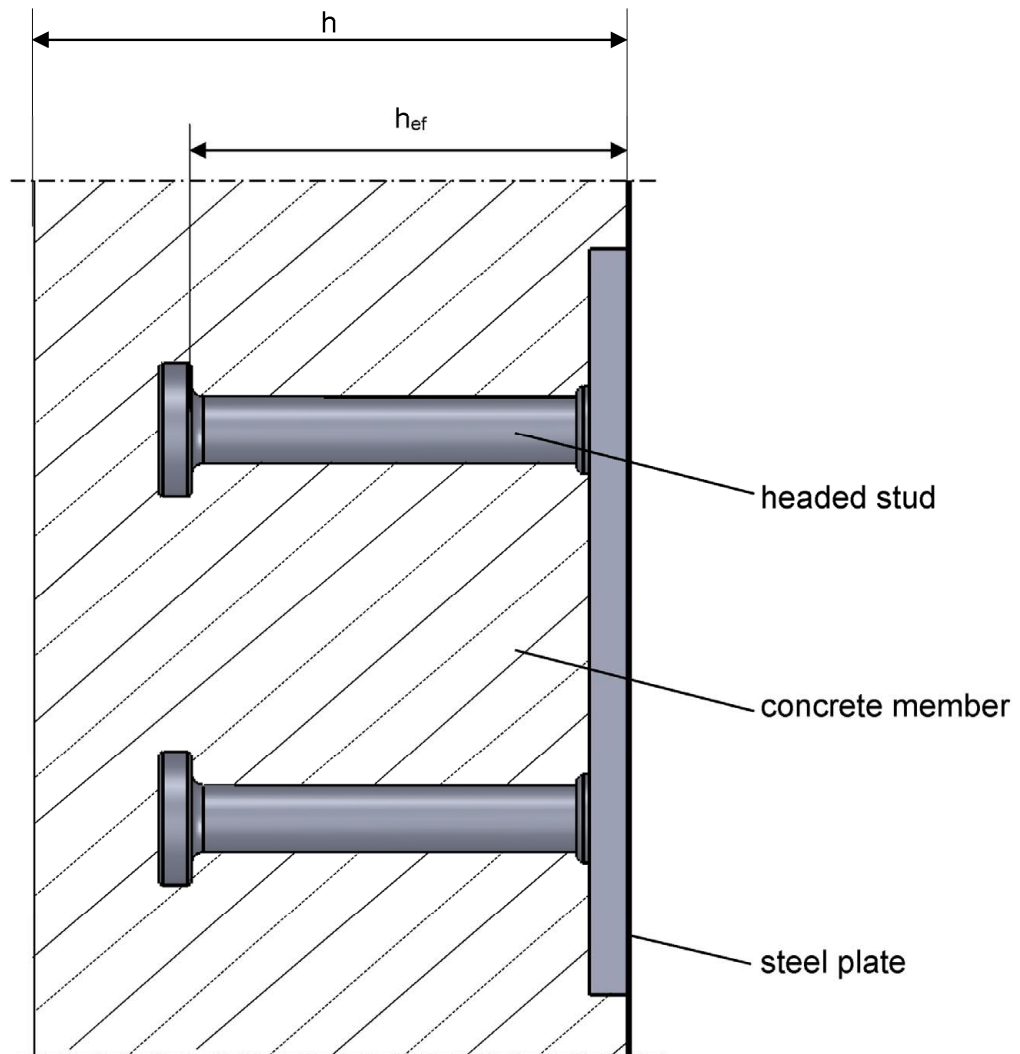

h_{ef} = effective anchorage depth
 h = thickness of concrete member

SB headed studs

Product description
Installed condition

Annex A1

Marking

Steel

Stainless steel

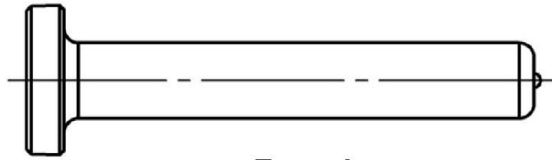

Form A

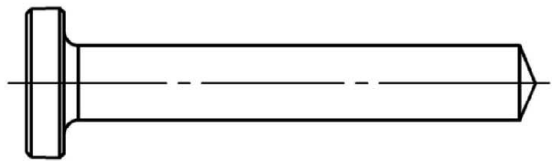
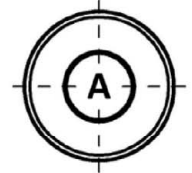
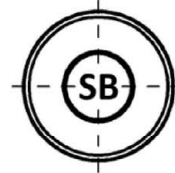

Form B

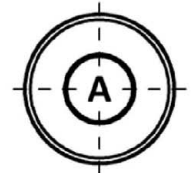
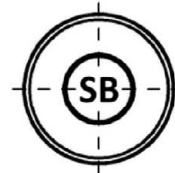

Marking SB = Identifying mark of the producer and material according to Annex A3, Table 2, Part 1

Marking A = identifying mark of the producer and material according to Annex A4, Table 3, Part 1

Table 1: Dimensions

Headed stud typ	Shaft \varnothing d [mm]	Head \varnothing d _h [mm]	Nominal length		Thickness of the head t _h [mm]
			min h _n [mm]	max h _n [mm]	
10	10	19	50	200	7.1
13	13	25	50	400	8
16	16	32	50	525	8
19	19	32	75	525	10
22	22	35	75	525	10
25 ¹⁾	25	40	75	525	12
25 ¹⁾	25	41	75	525	12

¹ Headed stud size 25 only of material according to Annex A3, Table 2, Part 1

SB headed studs

Product description
Headed studs dimensions and marking

Annex A2

Table 2: Material steel

Part	Denomination	Material	Mechanical properties	Intended use
1	Headed stud according to EN ISO 13918:2018 Type SD1	Killed steel according material group 1 ISO/TR 15608 within limits according to EN ISO 13918:2018, Table 2 (e.g. S235J2+C470 or S355 according to EN 10025-2:2019)	$f_{uk} \geq 470 \text{ N/mm}^2$ $f_{yk} \geq 375 \text{ N/mm}^2$	Steel plates with welded on headed studs may only be used in structures subject to dry internal conditions.
2	Steel plate	Steel according to EN 10025:2019 Steel S235JR; S235JO; S235J2 ----- Steel S355JO; S355J2, S355M ----- Steel S420M, S420N ----- Steel S460M ----- Steel S460N	See EN 10025:2019	

SB headed studs

Product description
Material steel

Annex A3

Table 3: Material stainless steel

Part	Denomination	Material	Mechanical properties	Intended use
1	Headed stud according to EN ISO 13918:2018, Type: SD3	Stainless steel 1.4301, 1.4303, 1.4306, 1.4307, 1.4401, 1.4404, 1.4571, 1.4432, 1.4436, 1.4439 according to EN 10088:2014	$f_{uk} = 540-780 \text{ N/mm}^2$, $f_{yk} \geq 350 \text{ N/mm}^2$	Steel plates with welded on headed studs may also be used in structures subject to external atmospheric exposure (including industrial and marine environment), or exposure in permanently damp internal conditions, if no particular aggressive conditions exist. Such particular aggressive conditions are e.g. permanent, alternating immersion in seawater or the splash zone of seawater, chloride atmosphere of indoor swimming pools or atmosphere with extreme chemical pollution (e.g. in desulphurization plants or road tunnels where de-icing materials are used).
2	Steel plate	Stainless steel 1.4401, 1.4404, 1.4571, 1.4432, 1.4436, 1.4439	See EN 10088:2014	

SB headed studs

Product description
Material stainless steel

Annex A4

Specifications of intended use

Steel plate with cast-in anchors subject to:

- Static and quasi-static loads in tension and shear.

Base materials:

- Reinforced normal weight concrete according to EN 206-1:2000.
- Strength classes C20/25 to C90/105 according to EN 206-1:2000.
- Cracked or uncracked concrete.

Use conditions (Environmental conditions):

- Structures subject to dry internal conditions (headed studs welded to steel plates according to Annex A3, Table 2)
- Structures subject to external atmospheric conditions (including industrial and marine environment) or exposure in permanently damp internal conditions, if no particular aggressive conditions (e.g. permanent, alternating immersion in seawater or the splash zone of seawater, chloride atmosphere of indoor swimming pools or atmosphere with chemical pollution e.g. desulphurization plants or road tunnels where de-icing materials are used) exist. (headed studs welded to steel plates according to Annex A4, Table 3)

Design:

- Steel plate with cast-in anchors are designed under the responsibility of an engineer experienced in anchorages and concrete work.
- Verifiable calculation notes and drawings are prepared taking account of the loads to be anchored. The position of the anchors is indicated on the design drawings (e.g. position of the anchor channel relative to the reinforcement or to supports).
- For static and quasi-static loading the steel plate with cast-in anchors are designed in accordance with CEN/TS 1992-4-2:2009.
- It is generally assumed that the concrete is cracked and that the occurring splitting forces are resisted by the reinforcement. The required cross section of the minimum reinforcement is determined according to CEN/TS 1992-4-2:2009 section 6.2.6.2 b).

Installation:

Welding of the headed studs to the steel plate

- Steel plates, on which headed studs made of steel will be welded, consist of the materials S235JR, S235JO, S235J2, S355JO and S355J2, S355M, S420M, S420N, S460M or S460N according to Annex A3, Table 2 or
Steel plates, on which headed studs made of stainless steel will be welded, consist of the materials 1.4401, 1.4404, 1.4571, 1.4432, 1.4436, 1.4439 according to Annex A4, Table 3.
- Headed studs shall be welded to the steel plate by means of drawn arc stud welding with ceramic ferrules or shielding gas in accordance with EN ISO 14555:2017 and EN ISO 3834:2005.
- Level of quality requirements corresponds to EN ISO 3834-3:2005.
- Possibly not homogeneous structure of the steel plate (e.g. lamellar tearing / lamellar imperfections) in the direction of the thickness is to be taken into account.
- Welding of the headed studs via arc stud welding may be performed in the manufacturing plant or on the construction site.
- For the welding of headed studs on the steel plate the executing company has a valid qualification for arc stud welding according to EN ISO 14555:2017.

SB headed studs

Intended use
Specifications

Annex B1

Placing steel plates into concrete

- The installation of headed studs is carried out by appropriately qualified personnel under the supervision of the person responsible for the technical matters on site.
- Use of the product only as supplied by the manufacturer.
- Installation in accordance with the installation instructions given in Annexes B5 and B6.
- The anchorages are fixed on the formwork, reinforcement or auxiliary construction such that no movement of the product will occur during the time of laying the reinforcement and of placing and compacting of the concrete.
- The concrete under the head of the headed studs is properly compacted.
- For large fixtures (steel plate > 400 mm x 400 mm) openings are provided, specified in the design drawings.

SB headed studs

Intended use
Specifications

Annex B2

Table 4: Installation parameters for headed studs made of steel

Nominal size (mm)		10	13	16	19	22	25
minimum effective anchorage depth	min h_{ef} [mm]	50	50	50	75	75	75
minimum spacing	s_{min} [mm]	50	70	80	100	100	100
minimum edge distance	c_{min} [mm]	50	50	50	70	70	100
minimum thickness of concrete member	h_{min} [mm]	$h_{ef} + t_h + c_{nom}^{1)}$					

¹⁾ c_{nom} = required concrete cover according to national regulations

Arrangement of headed studs (assembly instruction)

Regulations for the arrangement of headed studs on the plate are given in CEN/TS 1992-4-1:2009, section 1.2.3.

SB headed studs

Intended use
Installation parameters

Annex B3

Fig 1: Simple headed stud

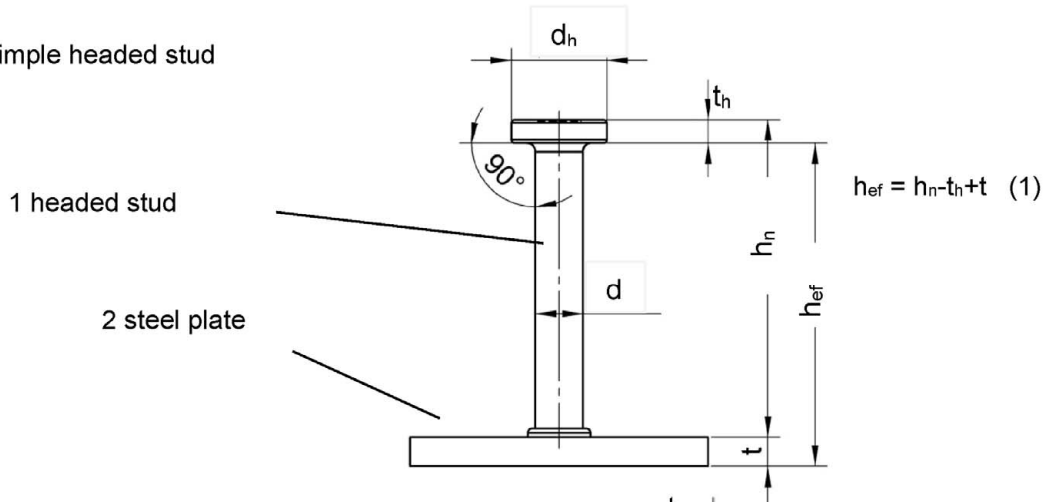

Fig 2: Doubled headed stud

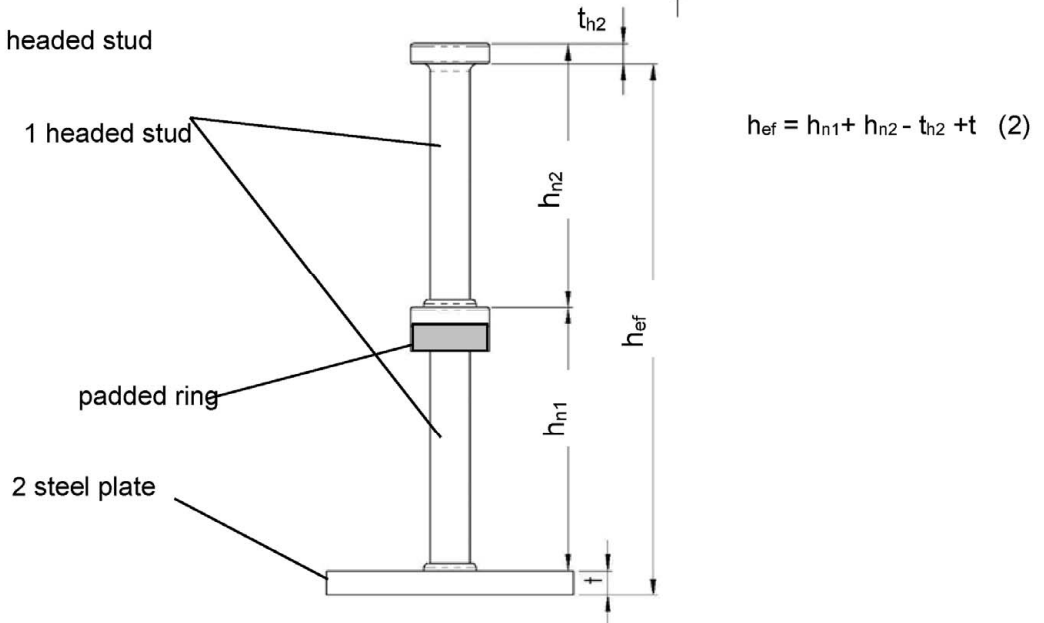
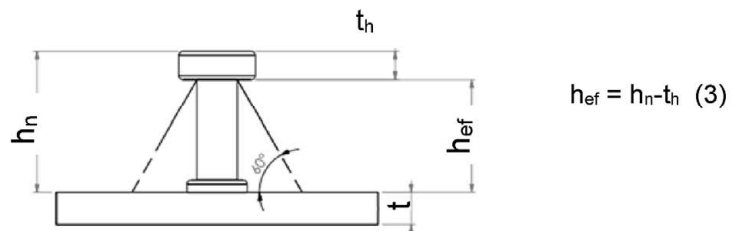

Fig 3: Short headed stud,
If the theoretic cone meets
the steel plate at an
angle of $\sim 60^\circ$

or $t \geq 0,2 h_n$



d = diameter of shaft
 d_h = diameter of head
 h_{ef} = effective anchorage depth
 h_n = nominal length of the headed stud (after welding)
 t_h = thickness of the head
 t = thickness of fixture (steel plate)

SB headed studs

Intended use
Effective embedment depth

Annex B4

Installation instruction

1 Welding headed studs to steel plate

- Confect steel plate (see relevant materials according to Annexes A3 and A4) according to design drawings,
- Weld headed studs to steel plate according method 783 of EN ISO 4063:2010 and at position according to design drawings.

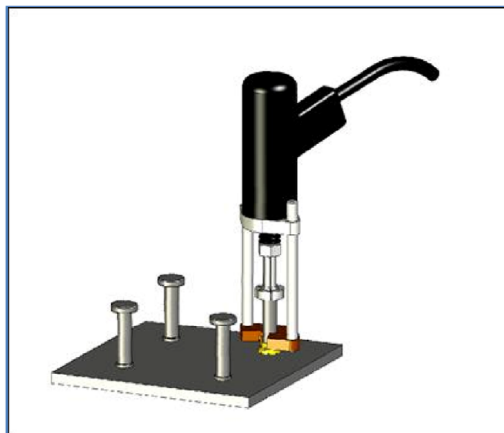

2 a Fixing steel plate to reinforcement

- Fix steel plate with headed studs directly to reinforcement or to mounting bar by wire binding,
- Fix in a way that steel plate does not move while pouring and compacting concrete,
- Orient steel plate surface-flush with the assumed concrete member.

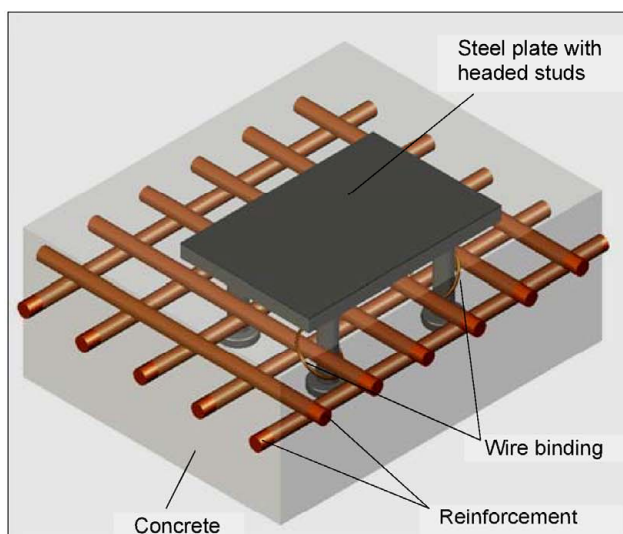

SB headed studs

Intended use
Installation instructions

Annex B5

2 b Fixing steel plate to formwork

- Fix steel plate with headed studs directly to formwork by nails, screws or wire binding,
- Control close contact between steel plate and formwork;
- Fix in a way that steel plate does not move while pouring and compacting concrete.

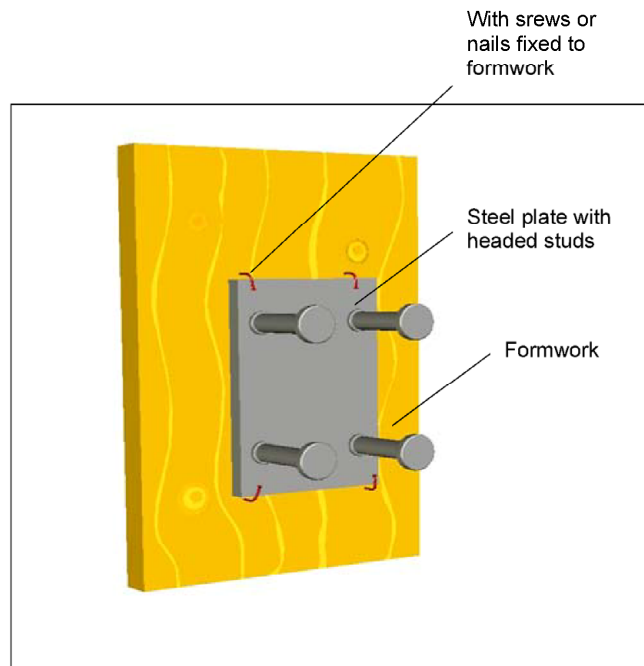

3 Pouring concrete and compacting concrete

- Compact concrete properly around steel plate and headed studs.

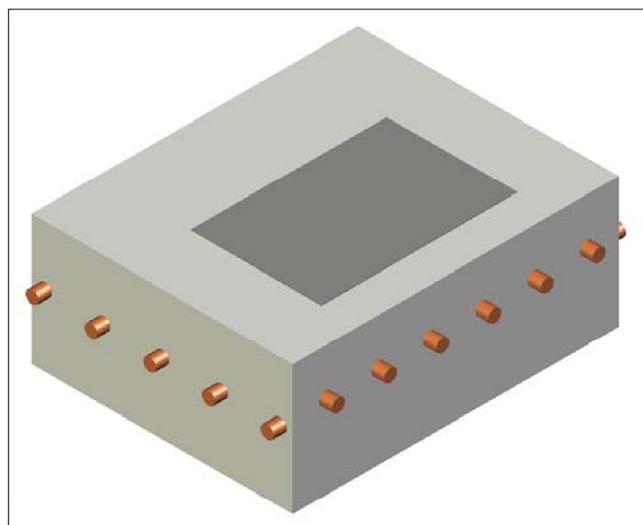

SB headed studs

Intended use
Installation instructions

Annex B6

Table 5: Characteristic values of resistance to tensile load for headed studs of steel and stainless steel

Headed stud - nominal size		10	13	16	19	22	25 ⁴⁾
Steel failure for headed studs made of steel							
Characteristic resistance	$N_{Rk,s}$ [kN]	37	62	94	133	179	231
Partial safety factor	γ_{Ms} ¹⁾	1.5					
Steel failure for headed studs made of stainless steel							
Characteristic resistance	$N_{Rk,s}$ [kN]	42	72	109	153	205	-
Partial safety factor	γ_{Ms} ¹⁾	1.85					
Pull-out failure for cracked concrete							
Charact. resistance C20/25	$N_{Rk,p}$ [kN]	30	53	90	78	87	114
Increasing factors ψ_c for $N_{Rk,p}$ $= N_{Rk,p} (C20/25) \cdot \psi_c$	C25/30	1.20					
	C30/37	1.48					
	C35/45	1.80					
	C40/50	2.00					
	C45/55	2.20					
	$\geq C50/60$	2.40					
Partial safety factor	γ_{Mp} ¹⁾	1.5					
Concrete cone failure and splitting							
Effective anchorage depth	h_{ef} [mm]	$h_n - t_h + t$ ²⁾					
factor to take into account the influence of load transfer mechanisms	k_{cr} [-]	8.5					
	k_{ucr} [-]	11.9					
Characteristic spacing	$s_{cr,N} = s_{cr,sp}$ ³⁾ [mm]	3 h_{ef}					
Characteristic edge distance	$c_{cr,N} = c_{cr,sp}$ ³⁾ [mm]	1.5 h_{ef}					
Partial safety factor	γ_{Mc} ¹⁾	1.5					
Blow-out failure							
Partial safety factor	γ_{Mcb} ¹⁾	1.5					

¹⁾ In absence of other national regulations

²⁾ For simple headed studs (for doubled headed studs resp. short headed studs see Fig.2 resp. 3, Annex B4)

³⁾ Reinforcement resists the splitting forces and limits the crack width to $w_w \leq 0.3$ mm

⁴⁾ Headed stud size 25 only of material according to Annex A3, Table 2, Part 1

Table 6: Displacement under tensile load

Headed stud - nominal size	10	13	16	19	22	25 ²⁾
Displacements δ_{NO} ¹⁾ to 0.7 mm under following loads in [kN]	15	22	31	31	35	48

¹⁾ The indicated displacements are valid for short term loading, the displacements $\delta_{N\infty}$ can increase under long term loading to 1,8 mm.

²⁾ Headed stud size 25 only of material according to Annex 3, Table 2, Part 1

SB headed studs

Performance data
Characteristic resistances and displacements under shear load

Annex C1

Table 7: Characteristic values of resistance to shear load for headed studs of steel and stainless steel

Headed studs - nominal size		10	13	16	19	22	25 ²⁾
Steel failure for headed studs made of steel							
Characteristic resistance	$V_{Rk,s}$ [kN]	22	37	57	80	107	138
Partial safety factor	γ_{Ms} ¹⁾	1.25					
Steel failure for headed studs made of stainless steel							
Characteristic resistance		25	43	65	92	123	-
Partial safety factor	γ_{Ms} ¹⁾	1.54					
Concrete pry-out failure							
Factor in equation (32) according to CEN/TS 1992-4.2:2009, section 6.3.4 without tensile reinforcement	K_3 ³⁾	2.0					
Partial safety factor	γ_{Mcp} ¹⁾	1.5					
Concrete edge failure							
Effective length of the headed stud	$l_f = h_{ef}$ [mm]	$h_n - t_h + t$ ⁴⁾					
Effective outside diameter	$d_{nom} = d$ [mm]	10	13	16	19	22	25
Partial safety factor	γ_{Mc} ¹⁾	1.5					

1) In absence of other national regulations

2) Headed stud size 25 only of material according to Annex A3, Table 2, Part 1

3) In case of supplementary reinforcement the factor k_3 shall be multiplied by 0.75

4) For simple headed studs (for doubled headed studs resp. short headed studs see Fig. 2 resp. 3, Annex B4)

Table 8: Displacements under shear load

Headed studs - nominal size	10	13	16	19	22	25 ²⁾
Displacements δ_{v0} ¹⁾ to 1.5 mm under following loads in [kN]	15	20	30	45	60	75

1) The indicated displacements are valid for short term loading, the displacements $\delta_{v\infty}$ can increase under long term loading to 2.0 mm

2) Headed stud size 25 only of material according to Annex A3, Table 2, Part 1

Combined tension and shear load

The factor k_7 is for combined tension and shear load according to CEN/TS 1992-4.2:2009, section 6.4.1.3

$$k_7 = 2/3$$

SB headed studs

Performance data
Characteristic resistances and displacements under shear load
Combined tension and shear load

Annex C2