

ZUBEHÖR *ACCESSORIES*

AUTOMATION



Inhaltsverzeichnis / Contents

1. Zubehör für Automatik-Bolzenschweißköpfe KHA-200F, KKA-200F, KHA-200, KKA-200 / Accessories for automatic stud welding heads KHA-200F, KKA-200F, KHA-200, KKA-200	5
1.1 Automatik-Bolzenhalter AT3 / <i>Automatic chuck AT3</i>	5
1.2 Automatik-Bolzenhalter AT1 / <i>Automatic chuck AT1</i>	6
1.3 Führungshülse / <i>Guide sleeve</i>	6
1.4 Ladestößel / <i>Ramming rod</i>	7
1.5 Einwurfrohr manuell / <i>Loading tube manual</i>	10
1.6 Einwurfrohr Automatik / <i>Loading tube automatic</i>	10
1.7 Kolben V KHA-200F, KKA-200F / <i>Piston V KHA-200F, KKA-200F</i>	11
1.8 Kolben V KHA-200, KKA-200 / <i>Piston V KHA-200, KKA-200</i>	11
1.9 Spannmutter KHA-200, KKA-200 / <i>Clamping nut KHA-200, KKA-200</i>	11
1.10 Längenanschlag / <i>Length stop</i>	12
1.11 Kolbenstange, Doppelnutring für Kolbenstange / <i>Piston rod, Seal with double groove for piston rod</i>	12
1.12 Überwurfmutter / <i>Lock nut</i>	13
1.13 Zentriervorrichtung / <i>Centring device</i>	13
1.14 Schutzgasvorrichtung / <i>Shielding gas device</i>	14
1.15 Adapter für Standard-Bolzenhalter CD / <i>Adapter for standard chucks CD</i>	14
1.16 Adapter für Hubzündungs-Bolzenhalter / <i>Adapter for drawn arc chucks</i>	15
2. Zubehör für Automatik-Bolzenschweißpistolen PHA-500, PKA-500, PHA-500-6 / Accessories for automatic stud welding guns PHA-500, PKA-500, PHA-500-6.....	16
2.1 Automatik-Bolzenhalter AT3 / <i>Automatic chuck AT3</i>	16
2.2 Automatik-Bolzenhalter AT1 / <i>Automatic chuck AT1</i>	17
2.3 Führungshülse / <i>Guide sleeve</i>	17
2.4 Ladestößel / <i>Ramming rod</i>	18
2.5 Einwurfrohr manuell / <i>Loading tube manual</i>	21
2.6 Einwurfrohr Automatik / <i>Loading tube automatic</i>	21
2.7 Kolben / <i>Piston</i>	23
2.8 Längenanschlag / <i>Length stop</i>	23
2.9 Kolbenstange, Doppelnutring für Kolbenstange / <i>Piston rod, Seal with double groove for piston rod</i>	24
2.10 Faltenbalg / <i>Bellows</i>	24
2.11 Überwurfmutter / <i>Lock nut</i>	24
2.12 Fuß / <i>Foot</i>	25
2.13 Zentriervorrichtung / <i>Centring device</i>	26
2.14 Schutzgasvorrichtung / <i>Shielding gas device</i>	27



3. Zubehör für automatische Bolzenzuführung VBZ / Accessories for automatic stud feeder VBZ	28
3.1 Ausrüstsatz VBZ / <i>Equipment kit VBZ</i>	28
3.2 Zuführrinne / <i>Feeding chute</i>	29
3.3 Schieber / <i>Pusher</i>	30
3.4 Zuführschlauch komplett / <i>Feeding tube complete</i>	31
3.5 Zuführschlauch (Meterware) / <i>Feeding tube (sold by the meter)</i>	32
3.6 Schlauchkupplung V M20, Kabelverschraubung M20/ <i>Hose coupling V, cable fitting M20</i>	33
3.7 Schlauchkupplung P / <i>Hose coupling P</i>	34
3.8 Sensor VBZ / <i>Sensor VBZ</i>	34
3.9 Steuerung VBZ / <i>Control VBZ</i>	35
4. Zubehör Automatik allgemein / Accessories automatic general	36
4.1 Pneumatikspanner STD / <i>Pneumatic clamp STD</i>	36
4.2 Spannpratzen für Pneumatikspanner STD / <i>Clamping claws for pneumatic clamp STD</i>	36
4.3 Pneumatik-Schwenkspanner, Öffnungswinkel 90° / <i>Pneumatic swing clamp, aperture angle 90°</i>	37
4.4 Spannpratzen für Pneumatik-Schwenkspanner, Öffnungswinkel 90° / <i>Pneumatic swing clamps, aperture angle 90°</i>	37
4.5 Mechanische Massezylinder für Automatikschweißkopf KHA-/KKA-200F / <i>Mechanical grounding cylinders for automatic welding head KHA-/KKA-200F</i>	38
4.6 Pneumatische Massezylinder für Automatikschweißkopf KHA-/KKA-200F / <i>Pneumatical grounding cylinders for automatic welding head KHA-/KKA-200F</i>	39
4.7 Werkstückanschlag lang / <i>Workpiece stop long</i>	40
4.8 Werkstückanschlag rund / <i>Workpiece stop round</i>	41
4.9 Anschlagstift Keramik / <i>Stop pin ceramic</i>	42
4.10 T-Nutenstein M5 / <i>T-nut M5</i>	43
4.11 T-Nutenstein M6 / <i>T-nut M6</i>	43
4.12 Einrichthilfe für Werkstückanschlag / <i>Positioning aid for workpiece stop</i>	44
4.13 Pneumatischer Werkstückspanner PWS 120 / <i>Pneumatic workpiece clamp PWS 120</i>	45
4.14 Arbeitshub AHP-080 für Automatik-Bolzenschweißkopf KHA-200F/KKA-200F/KHA-200/ KKA-200 / <i>Working lift AHP-080 for automatic stud welding head KHA-200F/KKA-200F/KHA-200/KKA-200</i>	46

1. Zubehör für Automatik-Bolzenschweißköpfe KHA-200F, KKA-200F, KHA-200, KKA-200 /
Accessories for automatic stud welding heads KHA-200F, KKA-200F, KHA-200, KKA-200

1.1 Automatik-Bolzenhalter AT3 /
Automatic chuck AT3

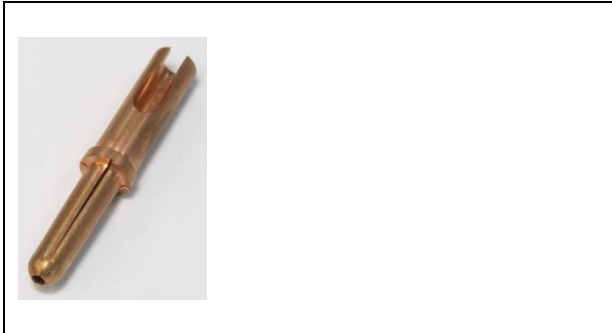

Beschreibung: Description: Automatik-Bolzenhalter AT3 <i>Automatic chuck AT3</i>	
---	--

Bolzen-Ø Stud Ø	Länge (mm) Length (mm)	Artikelnummer Item number
3	87	84-52-0003
4	87	84-52-0004
5	87	84-52-0005
6	87	84-52-0006
7,1	87	84-52-0071
8	87	84-52-0008



1.2 Automatik-Bolzenhalter AT1 / Automatic chuck AT1



Beschreibung:

Description:

Automatik-Bolzenhalter AT1

Automatic chuck AT1

Bolzen-Ø Stud Ø	Länge (mm) Length (mm)	Artikelnummer Item number
2	44	84-50-002
3	44	84-50-003
4	44	84-50-004
5	44	84-50-005
6	44	84-50-006
7,1	44	84-50-071
8	44	84-50-008
10	44	84-50-010

1.3 Führungshülse / Guide sleeve

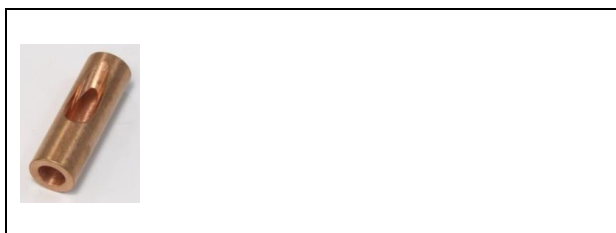

Beschreibung:

Description:

Führungshülse

Guide sleeve

Bolzen-Ø Stud Ø	Länge (mm) Length (mm)	Artikelnummer Item number
3	43	B-84-41-1301
4	43	B-84-41-1302
5	43	B-84-41-1303
6	43	B-84-41-1304
7,1 / 8	43	B-84-41-1305

1.4 Ladestößel / Ramming rod

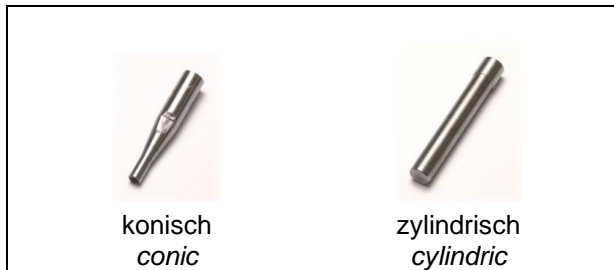

Beschreibung:

Description:

Ladestößel
Ramming rod

Bolzen-Ø Stud Ø	Bolzenlänge Stud length	Form Form	Länge (mm) Length (mm)	Artikelnummer Item number
3	6	konisch conic	33	B-84-70-2006
3	8	konisch conic	31	B-84-70-2008
3	10	konisch conic	30	B-84-70-2010
3	12	konisch conic	28	B-84-70-2012
3	15	konisch conic	25	B-84-70-2015
3	16	konisch conic	24	B-84-70-2016
3	20	zylindrisch cylindric	20	B-84-70-1020
3	25	zylindrisch cylindric	15	B-84-70-1025
3	30	zylindrisch cylindric	10	B-84-70-1030
3	35	zylindrisch cylindric	7	B-84-70-1035
3	40	zylindrisch cylindric	7	B-84-70-1035*
4	6	konisch conic	33	B-84-70-2006
4	8	konisch conic	31	B-84-70-2008
4	10	konisch conic	30	B-84-70-2010
4	12	konisch conic	28	B-84-70-2012
4	15	konisch conic	25	B-84-70-2015



Bolzen-Ø Stud Ø	Bolzenlänge Stud length	Form Form	Länge (mm) Length (mm)	Artikelnummer Item number
4	16	zylindrisch <i>cyllindric</i>	24	B-84-70-1016
4	20	zylindrisch <i>cyllindric</i>	20	B-84-70-1020
4	25	zylindrisch <i>cyllindric</i>	15	B-84-70-1025
4	30	zylindrisch <i>cyllindric</i>	10	B-84-70-1030
4	35	zylindrisch <i>cyllindric</i>	7	B-84-70-1035
4	40	zylindrisch <i>cyllindric</i>	7	B-84-70-1035*
5	8	zylindrisch <i>cyllindric</i>	31	B-84-70-1008
5	10	zylindrisch <i>cyllindric</i>	30	B-84-70-1010
5	12	zylindrisch <i>cyllindric</i>	28	B-84-70-1012
5	15	zylindrisch <i>cyllindric</i>	25	B-84-70-1015
5	16	zylindrisch <i>cyllindric</i>	24	B-84-70-1016
5	20	zylindrisch <i>cyllindric</i>	20	B-84-70-1020
5	25	zylindrisch <i>cyllindric</i>	15	B-84-70-1025
5	30	zylindrisch <i>cyllindric</i>	10	B-84-70-1030
5	35	zylindrisch <i>cyllindric</i>	7	B-84-70-1035
5	40	zylindrisch <i>cyllindric</i>	7	B-84-70-1035*
6	8	zylindrisch <i>cyllindric</i>	31	B-84-70-1008
6	10	zylindrisch <i>cyllindric</i>	30	B-84-70-1010
6	12	zylindrisch <i>cyllindric</i>	28	B-84-70-1012
6	15	zylindrisch <i>cyllindric</i>	25	B-84-70-1015
6	16	zylindrisch <i>cyllindric</i>	24	B-84-70-1016
6	20	zylindrisch <i>cyllindric</i>	20	B-84-70-1020
6	25	zylindrisch <i>cyllindric</i>	15	B-84-70-1025
6	30	zylindrisch <i>cyllindric</i>	10	B-84-70-1030



Bolzen-Ø Stud Ø	Bolzenlänge Stud length	Form Form	Länge (mm) Length (mm)	Artikelnummer Item number
6	35	zylindrisch <i>cylindric</i>	7	B-84-70-1035
6	40	zylindrisch <i>cylindric</i>	7	B-84-70-1035*
8	10	zylindrisch <i>cylindric</i>	30	B-84-70-1010
8	12	zylindrisch <i>cylindric</i>	28	B-84-70-1012
8	15	zylindrisch <i>cylindric</i>	25	B-84-70-1015
8	16	zylindrisch <i>cylindric</i>	24	B-84-70-1016
8	20	zylindrisch <i>cylindric</i>	20	B-84-70-1020
8	25	zylindrisch <i>cylindric</i>	15	B-84-70-1025
8	30	zylindrisch <i>cylindric</i>	10	B-84-70-1030
8	35	zylindrisch <i>cylindric</i>	7	B-84-70-1035
8	40	zylindrisch <i>cylindric</i>	7	B-84-70-1035*

*Bolzenlänge 40 mm nur für KKA-200F, KKA-200 / stud length 40 mm only for KKA-200F, KKA-200



1.5 Einwurfrohr manuell / Loading tube manual



Beschreibung: Description: Einwurfrohr manuell <i>Loading tube manual</i>	Anwendungsbereich: Field of application: Manuelle Bolzenzuführung <i>Manual stud feeding</i>
--	---

Bolzen-Ø Stud Ø	Länge (mm) Length (mm)	Artikelnummer Item number
3	108	B-84-40-2111
4	108	B-84-40-2112
5	108	B-84-40-2113
6	108	B-84-40-2114
7,1 / 8	108	B-84-40-2115

1.6 Einwurfrohr Automatik / Loading tube automatic

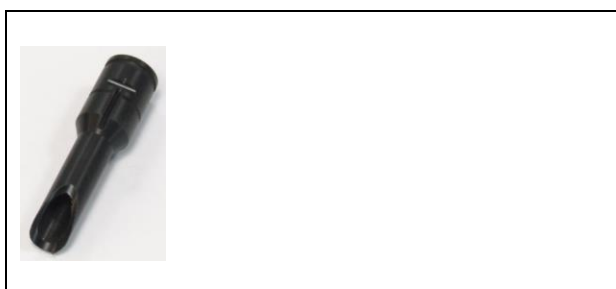

Beschreibung: Description: Einwurfrohr Automatik <i>Loading tube automatic</i>	Anwendungsbereich: Field of application: Automatische Bolzenzuführung <i>Automatic stud feeding</i>
---	--

Bolzen-Ø Stud Ø	Länge (mm) Length (mm)	Artikelnummer Item number
3	108	B-84-40-2211
4	108	B-84-40-2212
5	108	B-84-40-2213
6	108	B-84-40-2214
7,1 / 8	108	B-84-40-2215

**1.7 Kolben V KHA-200F, KKA-200F /
Piston V KHA-200F, KKA-200F**

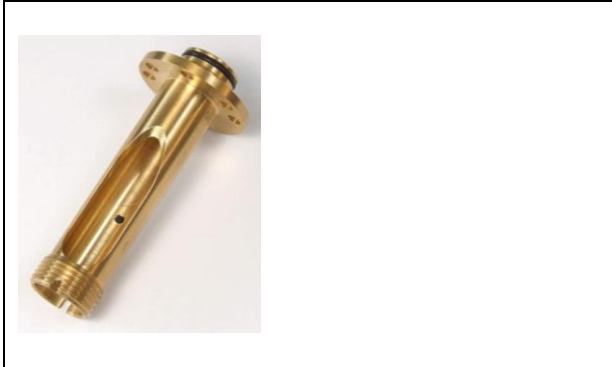

Beschreibung Description	Artikelnummer Item number
Kolben KHA-200F, KKA-200F <i>Piston KHA-200F, KKA-200F</i>	B-80-40-1909

**1.8 Kolben V KHA-200, KKA-200 /
Piston V KHA-200, KKA-200**



Beschreibung Description	Artikelnummer Item number
Kolben KHA-200, KKA-200 <i>Piston KHA-200, KKA-200</i>	B-80-40-1654

**1.9 Spannmutter KHA-200, KKA-200 /
Clamping nut KHA-200, KKA-200**



Beschreibung Description	Artikelnummer Item number
Spannmutter KHA-200, KKA-200 <i>Clamping nut KHA-200, KKA-200</i>	B-80-40-1655



1.10 Längenanschlag / Length stop

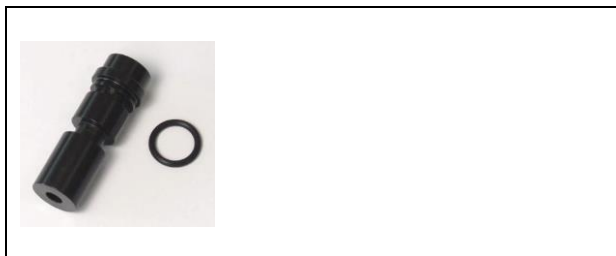

Beschreibung <i>Description</i>	Artikelnummer <i>Item number</i>
Längenanschlag <i>Length stop</i>	B-80-40-1657
O-Ring für Längenanschlag, außen <i>O-ring for length stop, external</i>	B-80-10-1077
O-Ring für Längenanschlag, innen <i>O-ring for length stop, internal</i>	B-80-10-1203

1.11 Kolbenstange, Doppelnutring für Kolbenstange / Piston rod, Seal with double groove for piston rod



Beschreibung <i>Description</i>	Artikelnummer <i>Item number</i>
Kolbenstange <i>Piston rod</i>	B-80-40-1656
Doppelnutring für Kolbenstange <i>Seal with double groove for piston rod</i>	B-80-10-1289

1.12 Überwurfmutter / Lock nut



Beschreibung <i>Description</i>	Artikelnummer <i>Item number</i>
Überwurfmutter <i>Lock nut</i>	B-80-40-1663

1.13 Zentriervorrichtung / Centring device



Beschreibung: Description: Zentriervorrichtung <i>Centring device</i>	
--	--

Nr. <i>No.</i>	Bezeichnung <i>Description</i>	Artikelnummer <i>Item number</i>
-	Zentriervorrichtung komplett <i>Centring device complete</i> Ø 30 mm	B-80-35-1234
1	Zentrierrohr <i>Centring tube</i> Ø 30 mm	B-80-40-0130
2	Flansch ZV <i>Flange ZV</i>	B-80-40-2192
3	Abstandsbolzen <i>Distance bolt</i>	B-80-40-1554
4	Schraube <i>Screw</i>	B-80-15-1181



**1.14 Schutzgasvorrichtung /
Shielding gas device**



Beschreibung Description	Artikelnummer Item number
Schutzgasvorrichtung <i>Shielding gas device</i>	B-90-50-1106
Schutzgasrohr M32 für Schutzgasvorrichtung <i>Shielding gas tube M32 for shielding gas device</i>	B-80-40-1188

**1.15 Adapter für Standard-Bolzenhalter CD /
Adapter for standard chucks CD**

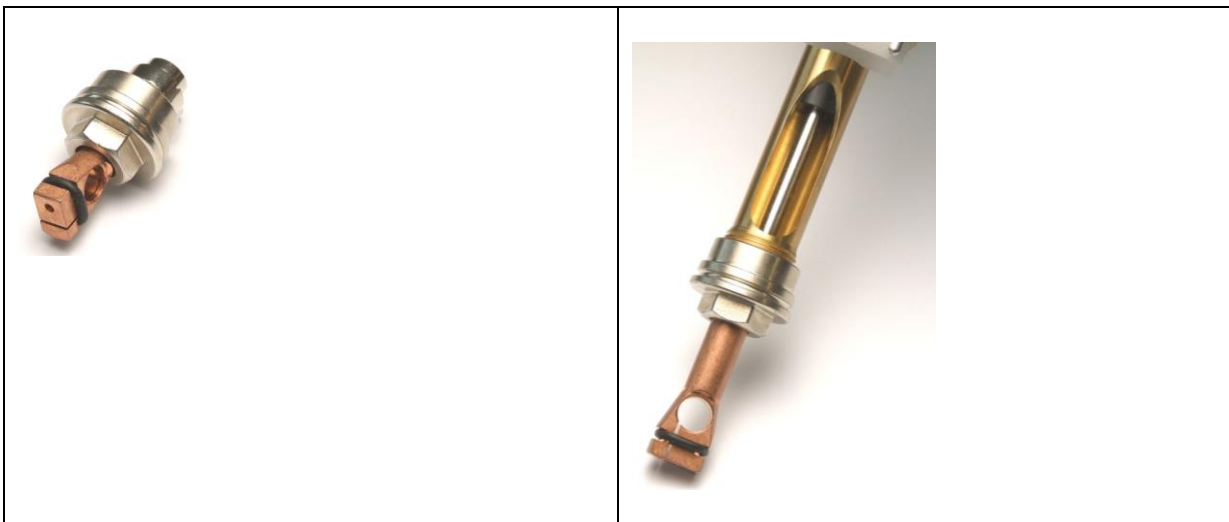

Beschreibung Description	Artikelnummer Item number
Adapter für Standard-Bolzenhalter CD <i>Adapter for standard chucks CD</i>	B-90-50-4010

**1.16 Adapter für Hubzündungs-Bolzenhalter /
Adapter for drawn arc chucks**

	<p>Anwendungsbereich: Field of application:</p> <ul style="list-style-type: none"> • Verwenden von Hubzündungsbolzenhaltern mit Innengewinde M10 an Automatikschweißköpfen KHA-200F/KHA-200 • Use of drawn arc chucks with internal thread M10 on automatic welding heads KHA-200F/KHA-200
---	--

<p>Beschreibung Description</p>	<p>Artikelnummer Item number</p>
<p>Adapter für Hubzündungs-Bolzenhalter Adapter for drawn arc chucks</p>	<p>B-80-40-2223</p>



**2. Zubehör für Automatik-Bolzenschweißpistolen PHA-500, PKA-500, PHA-500-6 /
Accessories for automatic stud welding guns PHA-500, PKA-500, PHA-500-6**

**2.1 Automatik-Bolzenhalter AT3 /
Automatic chuck AT3**



Beschreibung: Description: Automatik-Bolzenhalter AT3 <i>Automatic chuck AT3</i>	
---	--

Bolzen-Ø Stud Ø	Länge (mm) Length (mm)	Artikelnummer Item number
3	87	84-52-0003
4	87	84-52-0004
5	87	84-52-0005
6	87	84-52-0006
7,1	87	84-52-0071
8	87	84-52-0008

2.2 Automatik-Bolzenhalter AT1 / Automatic chuck AT1

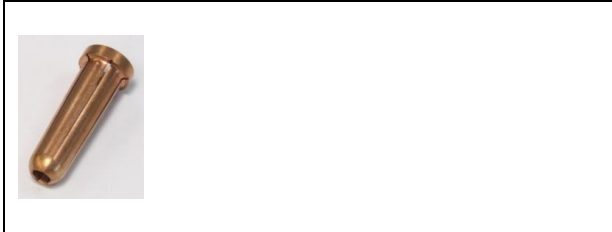

Beschreibung:

Description:

Automatik-Bolzenhalter AT1
Automatic chuck AT1

Bolzen-Ø Stud Ø	Länge (mm) Length (mm)	Artikelnummer Item number
2	44	84-50-002
3	44	84-50-003
4	44	84-50-004
5	44	84-50-005
6	44	84-50-006
7,1	44	84-50-071
8	44	84-50-008
10	44	84-50-010

2.3 Führungshülse / Guide sleeve

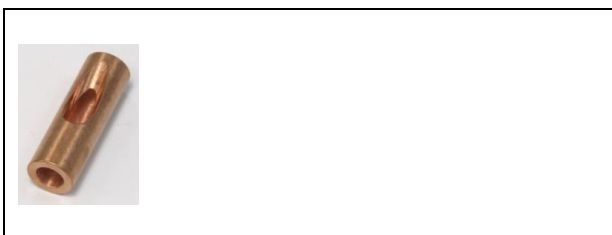

Beschreibung:

Description:

Führungshülse
Guide sleeve

Bolzen-Ø Stud Ø	Länge (mm) Length (mm)	Artikelnummer Item number
3	43	B-84-41-1301
4	43	B-84-41-1302
5	43	B-84-41-1303
6	43	B-84-41-1304
7,1 / 8	43	B-84-41-1305



2.4 Ladestößel / Ramming rod

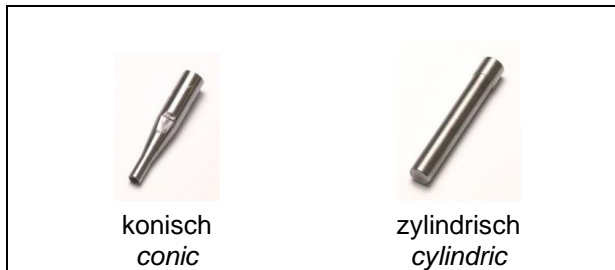

Beschreibung:

Description:

Ladestößel
Ramming rod

Bolzen-Ø <i>Stud Ø</i>	Bolzenlänge <i>Stud length</i>	Form <i>Form</i>	Länge (mm) <i>Length (mm)</i>	Artikelnummer <i>Item number</i>
3	6	konisch <i>conic</i>	33	B-84-70-2006
3	8	konisch <i>conic</i>	31	B-84-70-2008
3	10	konisch <i>conic</i>	30	B-84-70-2010
3	12	konisch <i>conic</i>	28	B-84-70-2012
3	15	konisch <i>conic</i>	25	B-84-70-2015
3	16	konisch <i>conic</i>	24	B-84-70-2016
3	20	zylindrisch <i>cylindric</i>	20	B-84-70-1020
3	25	zylindrisch <i>cylindric</i>	15	B-84-70-1025
3	30	zylindrisch <i>cylindric</i>	10	B-84-70-1030
3	35	zylindrisch <i>cylindric</i>	7	B-84-70-1035
3	40	zylindrisch <i>cylindric</i>	7	B-84-70-1035*
4	6	konisch <i>conic</i>	33	B-84-70-2006
4	8	konisch <i>conic</i>	31	B-84-70-2008
4	10	konisch <i>conic</i>	30	B-84-70-2010
4	12	konisch <i>conic</i>	28	B-84-70-2012
4	15	konisch <i>conic</i>	25	B-84-70-2015



Bolzen-Ø Stud Ø	Bolzenlänge Stud length	Form Form	Länge (mm) Length (mm)	Artikelnummer Item number
4	16	zylindrisch <i>cyllindric</i>	24	B-84-70-1016
4	20	zylindrisch <i>cyllindric</i>	20	B-84-70-1020
4	25	zylindrisch <i>cyllindric</i>	15	B-84-70-1025
4	30	zylindrisch <i>cyllindric</i>	10	B-84-70-1030
4	35	zylindrisch <i>cyllindric</i>	7	B-84-70-1035
4	40	zylindrisch <i>cyllindric</i>	7	B-84-70-1035*
5	8	zylindrisch <i>cyllindric</i>	31	B-84-70-1008
5	10	zylindrisch <i>cyllindric</i>	30	B-84-70-1010
5	12	zylindrisch <i>cyllindric</i>	28	B-84-70-1012
5	15	zylindrisch <i>cyllindric</i>	25	B-84-70-1015
5	16	zylindrisch <i>cyllindric</i>	24	B-84-70-1016
5	20	zylindrisch <i>cyllindric</i>	20	B-84-70-1020
5	25	zylindrisch <i>cyllindric</i>	15	B-84-70-1025
5	30	zylindrisch <i>cyllindric</i>	10	B-84-70-1030
5	35	zylindrisch <i>cyllindric</i>	7	B-84-70-1035
5	40	zylindrisch <i>cyllindric</i>	7	B-84-70-1035*
6	8	zylindrisch <i>cyllindric</i>	31	B-84-70-1008
6	10	zylindrisch <i>cyllindric</i>	30	B-84-70-1010
6	12	zylindrisch <i>cyllindric</i>	28	B-84-70-1012
6	15	zylindrisch <i>cyllindric</i>	25	B-84-70-1015
6	16	zylindrisch <i>cyllindric</i>	24	B-84-70-1016
6	20	zylindrisch <i>cyllindric</i>	20	B-84-70-1020
6	25	zylindrisch <i>cyllindric</i>	15	B-84-70-1025
6	30	zylindrisch <i>cyllindric</i>	10	B-84-70-1030



Bolzen-Ø Stud Ø	Bolzenlänge Stud length	Form Form	Länge (mm) Length (mm)	Artikelnummer Item number
6	35	zylindrisch <i>cyllindric</i>	7	B-84-70-1035
6	40	zylindrisch <i>cyllindric</i>	7	B-84-70-1035*
8	10	zylindrisch <i>cyllindric</i>	30	B-84-70-1010
8	12	zylindrisch <i>cyllindric</i>	28	B-84-70-1012
8	15	zylindrisch <i>cyllindric</i>	25	B-84-70-1015
8	16	zylindrisch <i>cyllindric</i>	24	B-84-70-1016
8	20	zylindrisch <i>cyllindric</i>	20	B-84-70-1020
8	25	zylindrisch <i>cyllindric</i>	15	B-84-70-1025
8	30	zylindrisch <i>cyllindric</i>	10	B-84-70-1030
8	35	zylindrisch <i>cyllindric</i>	7	B-84-70-1035
8	40	zylindrisch <i>cyllindric</i>	7	B-84-70-1035*

*Bolzenlänge 40 mm nur für PKA-500 / *stud length 40 mm only for PKA-500*

2.5 Einwurfrohr manuell / Loading tube manual

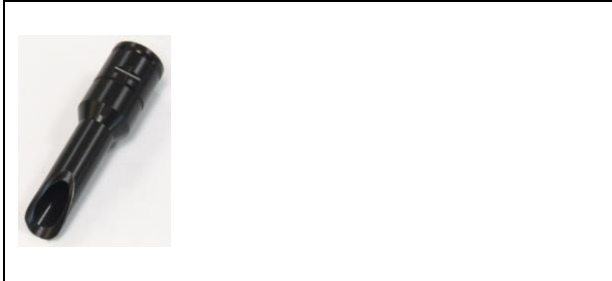

Beschreibung: Description: Einwurfrohr manuell <i>Loading tube manual</i>	Anwendungsbereich: Field of application: Manuelle Bolzenzuführung <i>Manual stud feeding</i>
--	---

Bolzen-Ø Stud Ø	Länge (mm) Length (mm)	Artikelnummer Item number
3	69	B-84-40-1101
4	69	B-84-40-1102
5	69	B-84-40-1103
6	69	B-84-40-1104
7,1 / 8	69	B-84-40-1105

2.6 Einwurfrohr Automatik / Loading tube automatic

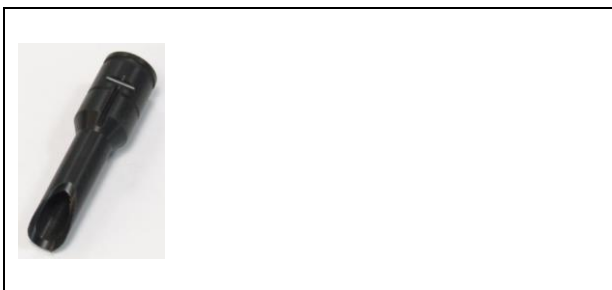

Beschreibung: Description: Einwurfrohr Automatik <i>Loading tube automatic</i>	Anwendungsbereich: Field of application: Automatische Bolzenzuführung <i>Automatic stud feeding</i>
---	--

Bolzen-Ø Stud Ø	Länge (mm) Length (mm)	Artikelnummer Item number
3	69	B-84-40-1201
4	69	B-84-40-1202
5	69	B-84-40-1203
6	69	B-84-40-1204
7,1 / 8	69	B-84-40-1205



2.7 Kolben / Piston



Beschreibung <i>Description</i>	Artikelnummer <i>Item number</i>
Kolben <i>Piston</i>	B-80-40-1398

2.8 Längenanschlag / Length stop

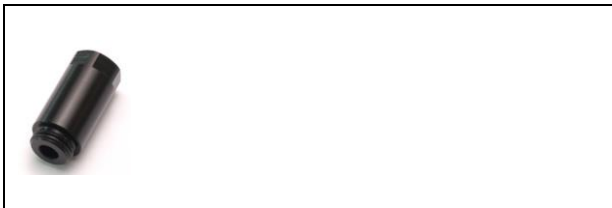

Beschreibung <i>Description</i>	Artikelnummer <i>Item number</i>
Längenanschlag <i>Length stop</i>	B-80-40-1296
O-Ring für Längenanschlag, innen <i>O-ring for length stop, internal</i>	B-80-10-1203



**2.9 Kolbenstange, Doppelnutring für Kolbenstange /
Piston rod, Seal with double groove for piston rod**



Beschreibung Description	Artikelnummer Item number
Kolbenstange <i>Piston rod</i>	B-80-40-1131
Doppelnutring für Kolbenstange <i>Seal with double groove for piston rod</i>	B-80-10-1070

**2.10 Faltenbalg /
Bellows**



Beschreibung Description	Artikelnummer Item number
Faltenbalg <i>Bellows</i>	B-80-40-1261

**2.11 Überwurfmutter /
Lock nut**



Beschreibung Description	Artikelnummer Item number
Überwurfmutter <i>Lock nut</i>	B-80-40-1091

**2.12 Fuß /
Foot**



Beschreibung <i>Description</i>	Artikelnummer <i>Item number</i>
Fuß <i>Foot</i>	B-80-40-1322



2.13 Zentriervorrichtung / Centring device



Beschreibung:
Description:
Zentriervorrichtung
Centring device

Nr. No.	Bezeichnung Description	Artikelnummer Item number
-	Zentriervorrichtung komplett Centring device complete Ø 20 mm Ø 22 mm Ø 26 mm Ø 30 mm	B-80-35-1120 B-80-35-1122 B-80-35-1126 B-80-35-1130
1	Zentrierrohr Centring tube Ø 20 mm Ø 22 mm Ø 26 mm Ø 30 mm	B-80-40-0120 B-80-40-0122 B-80-40-0126 B-80-40-0130
2	Flansch ZV Flange ZV	B-80-40-0483
3	Abstandsbolzen Distance bolt	B-80-40-1572
4	Schraube Screw	B-80-15-1181

2.14 Schutzgasvorrichtung / *Shielding gas device*



Beschreibung <i>Description</i>	Artikelnummer <i>Item number</i>
Schutzgasvorrichtung <i>Shielding gas device</i>	B-90-50-1116
Schutzgasrohr für Schutzgasvorrichtung <i>Shielding gas tube for shielding gas device</i>	B-80-40-1752



**3. Zubehör für automatische Bolzenzuführung VBZ /
Accessories for automatic stud feeder VBZ**

**3.1 Ausrüstsatz VBZ /
Equipment kit VBZ**



**Beschreibung:
Description:**

Ausrüstsatz VBZ
(Fördertopf mit Auslauf, Schieber, Zuführrinne,
Zuführschlauch)
Equipment kit
(Vibration conveyor pot, pusher, feeding chute,
feeding tube)

Bolzen-Ø Stud Ø	Bolzenlänge (mm) Stud length (mm)	Artikelnummer Item number
3	≤ 30	B-90-50-4303
4	≤ 30	B-90-50-4304
5	≤ 30	B-90-50-4305
6	≤ 30	B-90-50-4306
7,1	≤ 30	B-90-50-4307
8	≤ 30	B-90-50-4308
3	30 < x ≤ 50	B-90-50-4313
4	30 < x ≤ 50	B-90-50-4314
5	30 < x ≤ 50	B-90-50-4315
6	30 < x ≤ 50	B-90-50-4316
7,1	30 < x ≤ 50	B-90-50-4317
8	30 < x ≤ 50	B-90-50-4318

3.2 Zuführrinne / Feeding chute



Beschreibung:
Description:
Zuführrinne
Feeding chute

Bolzen-Ø Stud Ø	Bolzenlänge (mm) Stud length (mm)	Artikelnummer Item number
3	≤ 30	B-84-40-1603
4	≤ 30	B-84-40-1604
5	≤ 30	B-84-40-1605
6	≤ 30	B-84-40-1606
7,1	≤ 30	B-84-40-1671
8	≤ 30	B-84-40-1608
3	30 < x ≤ 50	B-84-41-1603
4	30 < x ≤ 50	B-84-41-1604
5	30 < x ≤ 50	B-84-41-1605
6	30 < x ≤ 50	B-84-41-1606
7,1	30 < x ≤ 50	B-84-41-1671
8	30 < x ≤ 50	B-84-41-1608



3.3 Schieber / Pusher



Beschreibung:

Description:

Schieber

Pusher

Bolzen-Ø Stud Ø	Bolzenlänge (mm) Stud length (mm)	Artikelnummer Item number
3	≤ 30	B-84-40-1703
4	≤ 30	B-84-40-1704
5	≤ 30	B-84-40-1705
6	≤ 30	B-84-40-1706
7,1	≤ 30	B-84-40-1771
8	≤ 30	B-84-40-1708
3	30 < x ≤ 50	B-84-41-1703
4	30 < x ≤ 50	B-84-41-1704
5	30 < x ≤ 50	B-84-41-1705
6	30 < x ≤ 50	B-84-41-1706
7,1	30 < x ≤ 50	B-84-41-1771
8	30 < x ≤ 50	B-84-41-1708

3.4 Zuführschlauch komplett / Feeding tube complete



Beschreibung:

Description:

Zuführschlauch komplett
mit Schlauchkupplung V und P
*Feeding tube complete
with hose coupling V and P*

Schlauchlänge <i>Tube length</i>	Bolzen-Ø <i>Stud Ø</i>	Artikelnummer <i>Item number</i>
4 m (Standard)	3	B-84-40-1843
4 m (Standard)	4	B-84-40-1844
4 m (Standard)	5	B-84-40-1845
4 m (Standard)	6	B-84-40-1846
4 m (Standard)	7,1 / 8	B-84-40-1848
6 m	3	B-84-40-1863
6 m	4	B-84-40-1864
6 m	5	B-84-40-1865
6 m	6	B-84-40-1866
6 m	7,1 / 8	B-84-40-1868
8 m	3	B-84-40-1883
8 m	4	B-84-40-1884
8 m	5	B-84-40-1885
8 m	6	B-84-40-1886
8 m	7,1 / 8	B-84-40-1888
10 m	3	B-84-40-1803
10 m	4	B-84-40-1804
10 m	5	B-84-40-1805
10 m	6	B-84-40-1806
10 m	7,1 / 8	B-84-40-1808



**3.5 Zuführschlauch (Meterware) /
Feeding tube (sold by the meter)**



Beschreibung:

Description:

Zuführschlauch (Meterware)
Feeding tube (sold by the meter)

Bolzen-Ø Stud Ø	Artikelnummer Item number
3	B-80-10-1193
4	B-80-10-1194
5	B-80-10-1195
6	B-80-10-1196
7,1 / 8	B-80-10-1198

3.6 Schlauchkupplung V M20, Kabelverschraubung M20/ Hose coupling V, cable fitting M20



Beschreibung:

Description:

Schlauchkupplung für VBZ
Hose coupling for VBZ

Nr. No.	Bezeichnung Description	Artikelnummer Item number
1	Schlauchkupplung M20 für Bolzen-Ø / Hose coupling M20 for stud Ø • 3 • 4 • 5 • 6 • 8	B-80-40-1233-1 B-80-40-1234-1 B-80-40-1235-1 B-80-40-1236-1 B-80-40-1238-1
2	Kabelverschraubung M20 Cable fitting M20	B-80-10-1583



3.7 Schlauchkupplung P / Hose coupling P



Beschreibung:

Description:

Schlauchkupplung für Automatik-
Schweißkopf/Automatik-Schweißpistole
*Hose coupling for automatic welding
head/automatic welding gun*

Bolzen-Ø Stud Ø	Artikelnummer Item number
3	B-80-40-1243
4	B-80-40-1244
5	B-80-40-1245
6	B-80-40-1246
7,1 / 8	B-80-40-1248

3.8 Sensor VBZ / Sensor VBZ



Beschreibung Description	Artikelnummer Item number
Sensor VBZ <i>Sensor VBZ</i>	B-80-50-1272

3.9 Steuerung VBZ / Control VBZ

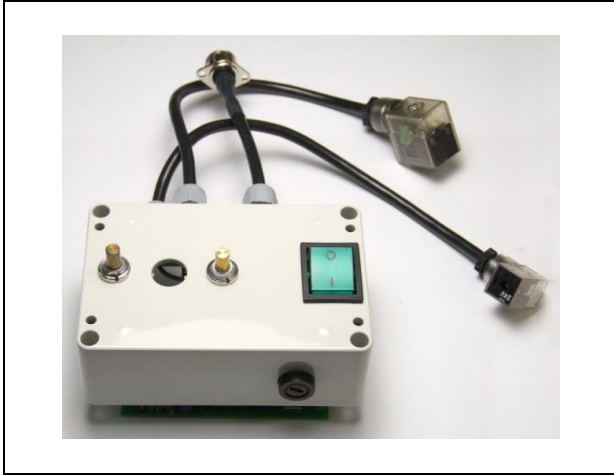

Beschreibung <i>Description</i>	Artikelnummer <i>Item number</i>
Steuerung VBZ <i>Control VBZ</i>	B-90-60-4010



**4. Zubehör Automatik allgemein /
Accessories automatic general**

**4.1 Pneumatikspanner STD /
Pneumatic clamp STD**



Pneumatischer Spanner für schnelles und exaktes Spannen und Positionieren von Werkstücken

- mit Vertikalbewegung
- ermöglicht das Einlegen von Werkstücken von vorne
- einstellbar für unterschiedliche Werkstückhöhen (max. Werkstückhöhe: 20 mm)

Pneumatic clamp for quick and accurate clamping and positioning of workpieces

- with vertical movement
- enables the insertion of workpieces from the front
- adjustable for different workpiece heights (max. workpiece height: 20 mm)

Beschreibung Description	Artikelnummer Item number
Pneumatikspanner STD <i>Pneumatic clamp STD</i>	B-90-50-1014

**4.2 Spannpratzen für Pneumatikspanner STD /
Clamping claws for pneumatic clamp STD**

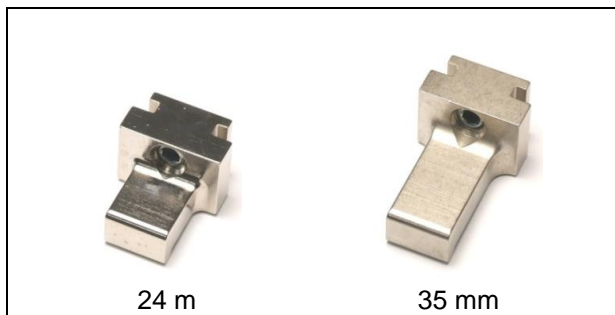

Beschreibung: Description: Spannpratze für Pneumatikspanner STD <i>Clamping claw for pneumatic clamp STD</i>	
---	--

Länge (mm) Length (mm)	Artikelnummer Item number
24 (Standard)	B-80-40-1032
35	B-80-40-1032-35
63	B-80-40-1032-63

4.3 Pneumatik-Schwenkspanner, Öffnungswinkel 90° / Pneumatic swing clamp, aperture angle 90°

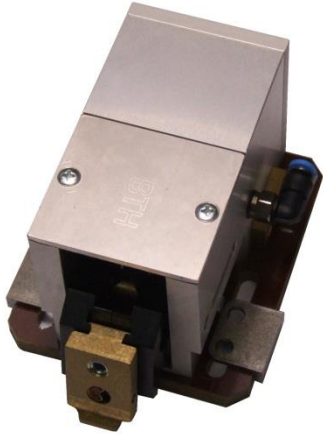
	<p>Pneumatischer Spanner für schnelles und exaktes Spannen und Positionieren von Werkstücken</p> <ul style="list-style-type: none"> • mit Horizontal- und Vertikalbewegung • ermöglicht das Einlegen von Werkstücken von oben und von vorne <p><i>Pneumatic clamp for quick and accurate clamping and positioning of workpieces</i></p> <ul style="list-style-type: none"> • with horizontal and vertical movement • enables the insertion of workpieces from the top and from the front
---	--

Beschreibung <i>Description</i>	Artikelnummer <i>Item number</i>
Pneumatik-Schwenkspanner, Öffnungswinkel 90° <i>Pneumatic swing clamp, aperture angle 90°</i>	B-90-50-1146

4.4 Spannpratzen für Pneumatik-Schwenkspanner, Öffnungswinkel 90° / Pneumatic swing clamps, aperture angle 90°

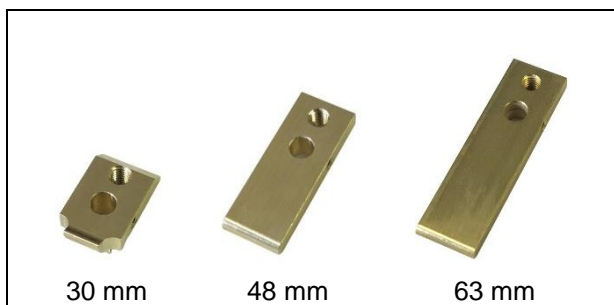

<p>Beschreibung: Description:</p> <p>Spannpratze für Pneumatik-Schwenkspanner, Öffnungswinkel 90° <i>Clamping claw for pneumatic swing clamp, aperture angle 90°</i></p>	
--	--

Länge (mm) <i>Length (mm)</i>	Artikelnummer <i>Item number</i>
30	B-80-40-1032-1
48	B-80-40-1032-2
63	B-80-40-1032-4

4.5 Mechanische Massezylinder für Automatikschweißkopf KHA-/KKA-200F / Mechanical grounding cylinders for automatic welding head KHA-/KKA-200F



Nr. No.	Bezeichnung Description	Artikelnummer Item number
-	Mechanische Massezylinder für KHA-/KKA-200F (komplett) <i>Mechanical grounding cylinders for KHA-/KKA-200F (complete)</i>	B-90-50-1107-1
1	Massekontakt <i>Grounding contact</i>	B-80-40-2273
2	Stellring <i>Adjusting collar</i>	B-80-10-1581
3	Verbindungskabel <i>Connecting cable</i>	B-80-72-1165-1
4	Druckfeder <i>Pressure spring</i>	B-80-40-1920
5	Führungsbuchse <i>Guide sleeve</i>	B-80-40-2271
6	Endplatte KHA-/KKA-200F <i>End plate KHA-/KKA-200F</i>	B-80-40-2270
7	Führungsbolzen <i>Guide bolt</i>	B-80-40-2272

4.6 Pneumatische Massezylinder für Automatikschweißkopf KHA-/KKA-200F / Pneumatical grounding cylinders for automatic welding head KHA-/KKA-200F

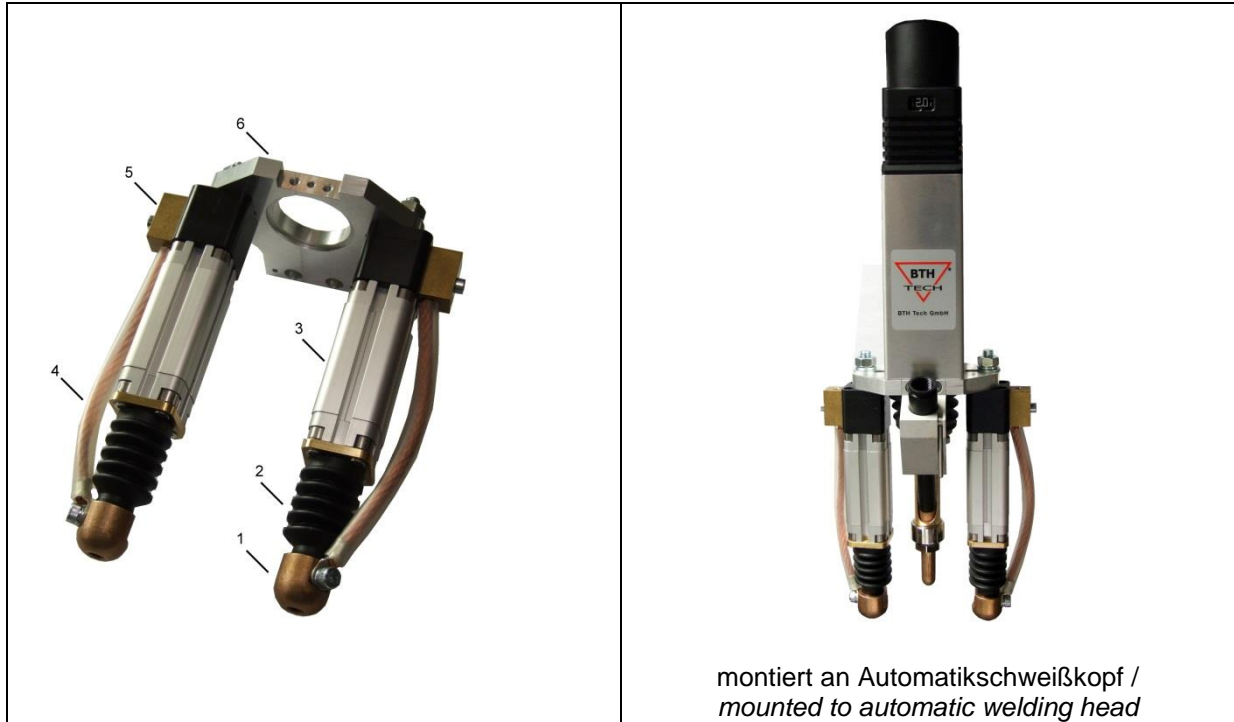

Nr. No.	Bezeichnung Description	Artikelnummer Item number
-	Pneumatische Massezylinder für KHA-/KKA-200F (komplett) <i>Pneumatical grounding cylinders for KHA-/KKA-200F (complete)</i>	B-90-50-1107-2
1	Masekontakt <i>Grounding contact</i>	B-80-40-1719
2	Faltenbalg <i>Bellows</i>	B-80-20-1010
3	Kurzhubzylinder <i>Short stroke cylinder</i>	B-80-10-1327
4	Verbindungskabel <i>Connecting cable</i>	B-80-72-1165
5	Kontaktklotz <i>Contact block</i>	B-80-40-1718
6	Endplatte KHA-/KKA-200F <i>End plate KHA-/KKA-200F</i>	B-80-40-1735-1



**4.7 Werkstückanschlag lang /
Workpiece stop long**



Beschreibung:

Description:

Werkstückanschlag lang
Workpiece stop long

Nr. No.	Bezeichnung Description	Artikelnummer Item number
-	Werkstückanschlag lang Workpiece stop long	B-80-35-1363
1	Anschlagblech verstellbar Stop plate adjustable	B-80-40-2239
2	Isolierstück für Werkstückanschlag Insulating piece for workpiece stop	B-80-40-2242
3	Scheibe Disk	B-80-15-1167
4	Zylinderschraube Cylinder screw	C-15-0001-5X20
5	T-Nutenstein M5 T-nut M5	B-80-10-1462-1

4.8 Werkstückanschlag rund / *Workpiece stop round*

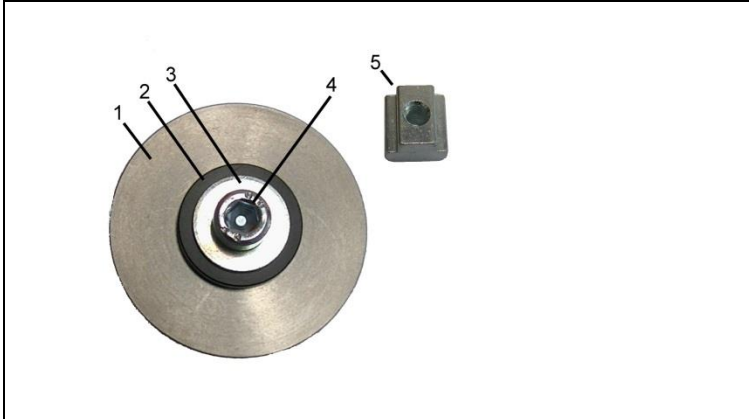

Beschreibung:

Description:

Werkstückanschlag rund
Workpiece stop round

Nr. No.	Bezeichnung Description	Artikelnummer Item number
-	Werkstückanschlag rund <i>Workpiece stop round</i>	B-80-35-1364
1	Anschlagscheibe <i>Stop disk</i>	B-80-40-2241
2	Isolierstück für Werkstückanschlag <i>Insulating piece for workpiece stop</i>	B-80-40-2242
3	Scheibe <i>Disk</i>	B-80-15-1167
4	Zylinderschraube <i>Cylinder screw</i>	C-15-0001-5X20
5	T-Nutenstein M5 <i>T-nut M5</i>	B-80-10-1462-1

4.9 Anschlagstift Keramik / Stop pin ceramic

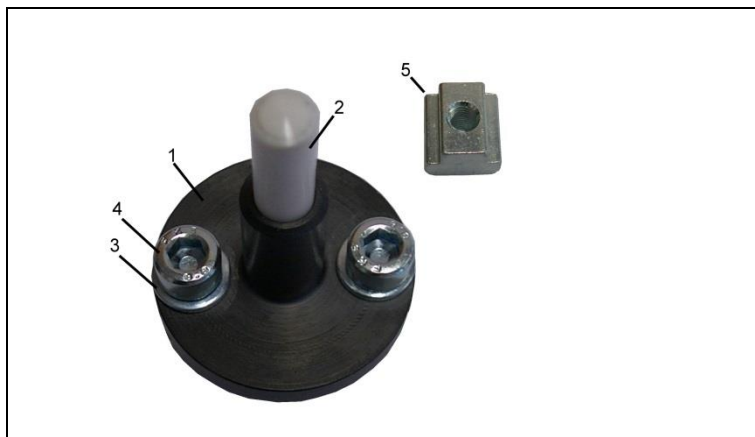

Beschreibung:

Description:

Anschlagstift Keramik
Stop pin ceramic

Nr. No.	Bezeichnung Description	Artikelnummer Item number
-	Anschlagstift Keramik Stop pin ceramic	B-80-35-1359
1	Buchse Socket	B-80-40-2300
2	Pin Keramik Pin ceramic	B-80-40-2300-1
3	Scheibe Disk	B-80-15-1167
4	Zylinderschraube Cylinder screw	B-80-15-1101
5	T-Nutenstein M6 T-nut M6	B-80-10-1462

**4.10 T-Nutenstein M5 /
T-nut M5**

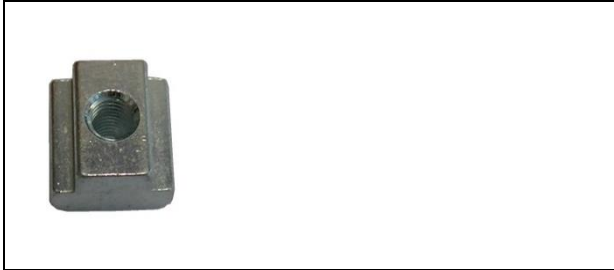

Beschreibung Description	Artikelnummer Item number
T-Nutenstein M5 <i>T-nut M5</i>	B-80-10-1462-1

**4.11 T-Nutenstein M6 /
T-nut M6**



Beschreibung Description	Artikelnummer Item number
T-Nutenstein M6 <i>T-nut M6</i>	B-80-10-1462



**4.12 Einrichthilfe für Werkstückanschlag /
*Positioning aid for workpiece stop***

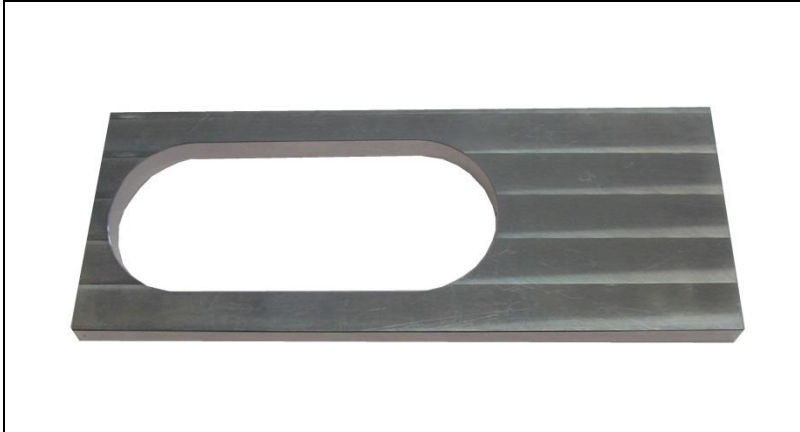

Beschreibung <i>Description</i>	Artikelnummer <i>Item number</i>
Einrichthilfe für Werkstückanschlag / <i>Positioning aid for workpiece stop</i>	B-80-40-2240

4.13 Pneumatischer Werkstückspanner PWS 120 / *Pneumatic workpiece clamp PWS 120*

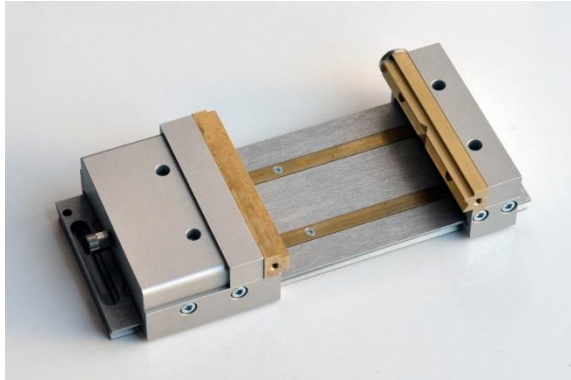

Pneumatischer Spanner zur schnellen und zuverlässigen Einspannung und Positionierung von Werkstücken

- auswechselbare, bearbeitbare Spannbacken
- direkte Zuführung der Masse über die Spannbacken reduziert die magnetische Blaswirkung
- großes Spannfeld von 120 mm
- flacher Aufbau (nur 45 mm)
- wiederholgenaue Montage auf CNC-Bolzenschweißanlage/Tisch-Bolzenschweißanlage MAS-04 durch Passstiftbohrungen in der Grundplatte
- wiederholgenaues Einlegen von Werkstücken durch Anschlagposition (Anschlagscheibe)

Pneumatic clamp for quick and reliable fixing and positioning of workpieces

- *exchangeable, machineable clamping jaws*
- *direct grounding through the clamping jaws reduces magnetic arc blowing action*
- *big clamping field of 120 mm*
- *lowprofile body (only 45 mm)*
- *repetitive assembly on CNC stud welding machine/tabletop stud welding machine MAS-04 through dowel holes in the base plate*
- *repetitive placing of workpieces through stop position (stop washer)*

Beschreibung <i>Description</i>	Artikelnummer <i>Item number</i>
Pneumatischer Werkstückspanner PWS 120 <i>Pneumatic workpiece clamp PWS 120</i>	B-90-50-1156



4.14 Arbeitshub AHP-080 für Automatik-Bolzenschweißkopf KHA-200F/KKA-200F/KHA-200/KKA-200 /
Working lift AHP-080 for automatic stud welding head KHA-200F/KKA-200F/KHA-200/KKA-200

	<p>Arbeitshub zur vertikalen Positionierung der Schweißköpfe KHA-200F und KKA-200F</p> <ul style="list-style-type: none"> • schnelles und passgenaues Anbringen des Schweißkopfs durch Spezialkupplung • verschraubte Stromzuführungen zur Vermeidung versteckter Fehlerquellen • neuartiges Kabelführungssystem zur Verhinderung von Kabelbeschädigungen • pneumatischer Hub: 80 mm • mechanischer Verstellweg: 40 mm <p><i>Working lift for the vertical positioning of welding heads KHA-200F and KKA-200F</i></p> <ul style="list-style-type: none"> • <i>fast and accurately fitting of welding head through special coupling</i> • <i>screwed current supplys to avoid hidden error sources</i> • <i>innovative cable guidance system to prevent cable damages</i> • <i>pneumatic lift: 80 mm</i> • <i>mechanic adjusting range: 40 mm</i>
--	--

Beschreibung <i>Description</i>	Artikelnummer <i>Item number</i>
Arbeitshub AHP-080 <i>Working lift AHP-080</i>	B-90-50-1090



Bolte GmbH

Flurstraße 25
D-58285 Gevelsberg

Tel.: +49 (0)2332 55106-0
Fax: +49 (0)2332 55106-11

Ohmstraße 3
D-85221 Dachau

Tel.: +49 (0)8131 5159-0
Fax: +49 (0)8131 5159-11

E-Mail: info@bolte.gmbh



www.bolte.gmbh